

# Silicon Diffused Power Transistor

**BU1508AX**

## GENERAL DESCRIPTION

Enhanced performance, new generation, high-voltage, high-speed switching npn transistor in a plastic full-pack envelope intended for use in horizontal deflection circuits of colour television receivers. Features exceptional tolerance to base drive and collector current load variations resulting in a very low worst case dissipation.

## QUICK REFERENCE DATA

SYMBOL	PARAMETER	CONDITIONS	TYP.	MAX.	UNIT
$V_{CESM}$	Collector-emitter voltage peak value	$V_{BE} = 0\text{ V}$	-	1500	V
$V_{CEO}$	Collector-emitter voltage (open base)		-	700	V
$I_C$	Collector current (DC)		-	8	A
$I_{CM}$	Collector current peak value		-	15	A
$P_{tot}$	Total power dissipation	$T_{hs} \leq 25\text{ }^\circ\text{C}$	-	35	W
$V_{CEsat}$	Collector-emitter saturation voltage	$I_C = 4.5\text{ A}; I_B = 1.1\text{ A}$	-	1.0	V
$I_{CSat}$	Collector saturation current		4.5	-	A
$t_f$	Fall time	$I_{CM} = 4.5\text{ A}; I_{B(end)} = 1.1\text{ A}$	0.4	0.6	$\mu\text{s}$

## PINNING - SOT186A

PIN	DESCRIPTION
1	base
2	collector
3	emitter
case	isolated

## PIN CONFIGURATION

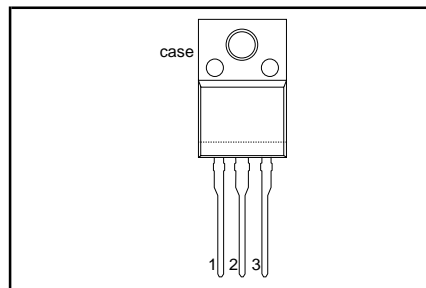

## SYMBOL

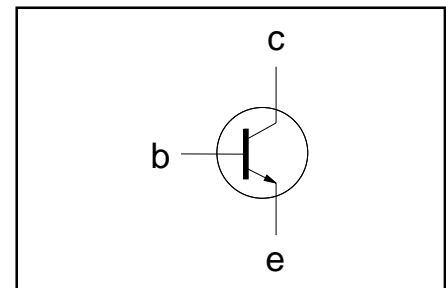

## LIMITING VALUES

Limiting values in accordance with the Absolute Maximum Rating System (IEC 134)

SYMBOL	PARAMETER	CONDITIONS	MIN.	MAX.	UNIT
$V_{CESM}$	Collector-emitter voltage peak value	$V_{BE} = 0\text{ V}$	-	1500	V
$V_{CEO}$	Collector-emitter voltage (open base)		-	700	V
$I_C$	Collector current (DC)		-	8	A
$I_{CM}$	Collector current peak value		-	15	A
$I_B$	Base current (DC)		-	4	A
$I_{BM}$	Base current peak value		-	6	A
$-I_{B(AV)}$	Reverse base current	average over any 20 ms period	-	100	mA
$-I_{BM}$	Reverse base current peak value <sup>1</sup>		-	5	A
$P_{tot}$	Total power dissipation	$T_{hs} \leq 25\text{ }^\circ\text{C}$	-	35	W
$T_{stg}$	Storage temperature		-65	150	$^\circ\text{C}$
$T_j$	Junction temperature		-	150	$^\circ\text{C}$

## THERMAL RESISTANCES

SYMBOL	PARAMETER	CONDITIONS	TYP.	MAX.	UNIT
$R_{th\ j-hs}$	Junction to heatsink	with heatsink compound	-	3.6	K/W
$R_{th\ j-a}$	Junction to ambient	in free air	55	-	K/W

<sup>1</sup> Turn-off current.

## Silicon Diffused Power Transistor

BU1508AX

**ISOLATION LIMITING VALUE & CHARACTERISTIC** $T_{hs} = 25\text{ }^{\circ}\text{C}$  unless otherwise specified

SYMBOL	PARAMETER	CONDITIONS	MIN.	TYP.	MAX.	UNIT
$V_{isol}$	R.M.S. isolation voltage from all three terminals to external heatsink	$f = 50\text{-}60\text{ Hz}$ ; sinusoidal waveform; $R.H. \leq 65\%$ ; clean and dustfree	-		2500	V
$C_{isol}$	Capacitance from T2 to external heatsink	$f = 1\text{ MHz}$	-	10	-	pF

**STATIC CHARACTERISTICS** $T_{hs} = 25\text{ }^{\circ}\text{C}$  unless otherwise specified

SYMBOL	PARAMETER	CONDITIONS	MIN.	TYP.	MAX.	UNIT
$I_{CES}$	Collector cut-off current <sup>2</sup>	$V_{BE} = 0\text{ V}$ ; $V_{CE} = V_{CESMmax}$	-	-	1.0	mA
$I_{CES}$		$V_{BE} = 0\text{ V}$ ; $V_{CE} = V_{CESMmax}$ ; $T_j = 125\text{ }^{\circ}\text{C}$	-	-	2.0	mA
$I_{EBO}$	Emitter cut-off current	$V_{EB} = 7.5\text{ V}$ ; $I_C = 0\text{ A}$	-	-	1.0	mA
$BV_{EBO}$	Emitter-base breakdown voltage	$I_B = 1\text{ mA}$	7.5	13.5	-	V
$V_{CEOsust}$	Collector-emitter sustaining voltage	$I_B = 0\text{ A}$ ; $I_C = 100\text{ mA}$ ; $L = 25\text{ mH}$	700	-	-	V
$V_{CEsat}$	Collector-emitter saturation voltage	$I_C = 4.5\text{ A}$ ; $I_B = 1.1\text{ A}$	-	-	1.0	V
$V_{BEsat}$	Base-emitter saturation voltage	$I_C = 4.5\text{ A}$ ; $I_B = 1.7\text{ A}$	-	-	1.1	V
$h_{FE}$	DC current gain	$I_C = 100\text{ mA}$ ; $V_{CE} = 5\text{ V}$	-	13	-	
$h_{FE}$		$I_C = 4.5\text{ A}$ ; $V_{CE} = 1\text{ V}$	4.0	5.5	7.0	

**DYNAMIC CHARACTERISTICS** $T_{hs} = 25\text{ }^{\circ}\text{C}$  unless otherwise specified

SYMBOL	PARAMETER	CONDITIONS	TYP.	MAX.	UNIT
$C_c$	Collector capacitance	$I_E = 0\text{ A}$ ; $V_{CB} = 10\text{ V}$ ; $f = 1\text{ MHz}$	80	-	pF
$t_s$	Switching times (line deflection circuit)	$I_{CM} = 4.5\text{ A}$ ; $I_{B(end)} = 1.1\text{ A}$ ; $L_B = 6\text{ }\mu\text{H}$ ; $-V_{BB} = 4\text{ V}$ ; $(-di_B/dt = 0.6\text{ A}/\mu\text{s})$			
$t_s$	Turn-off storage time		5.0	6.0	$\mu\text{s}$
$t_f$	Turn-off fall time		0.4	0.6	$\mu\text{s}$

<sup>2</sup> Measured with half sine-wave voltage (curve tracer).

Silicon Diffused Power Transistor

BU1508AX

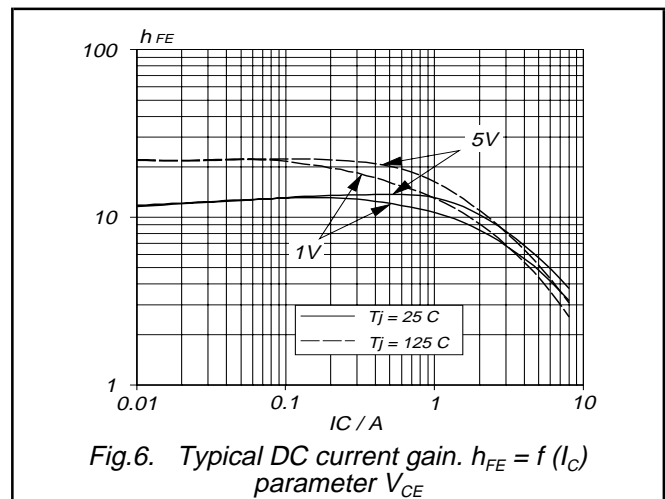
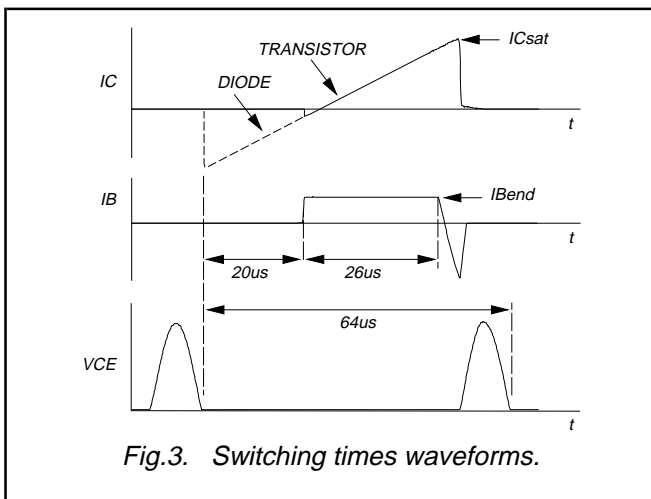
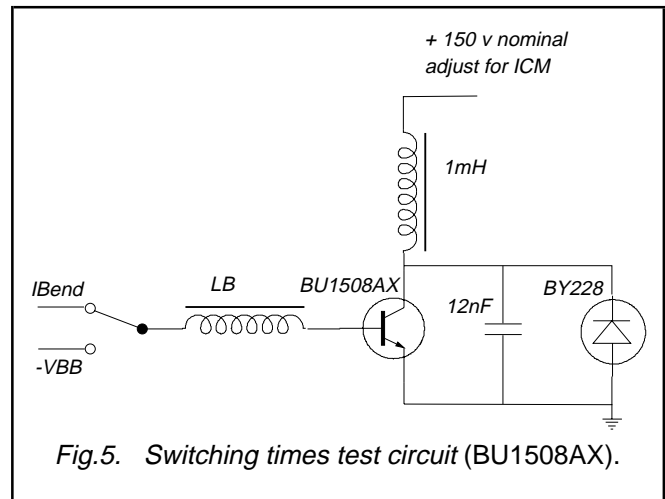
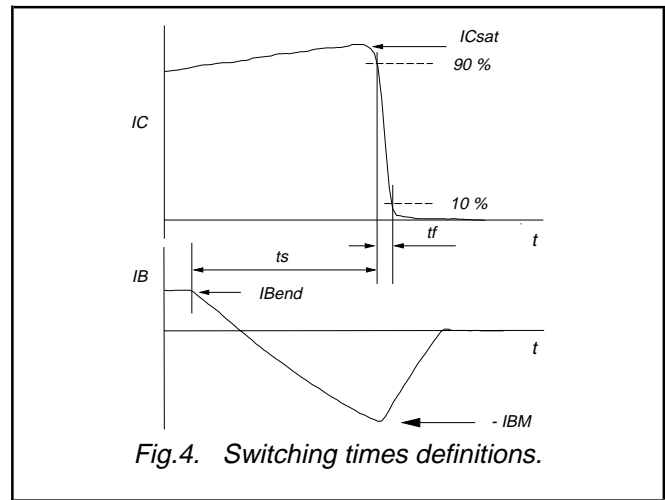

Silicon Diffused Power Transistor

BU1508AX

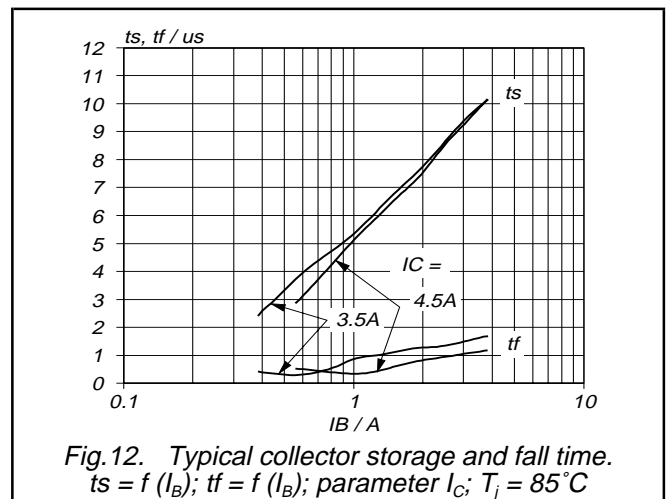
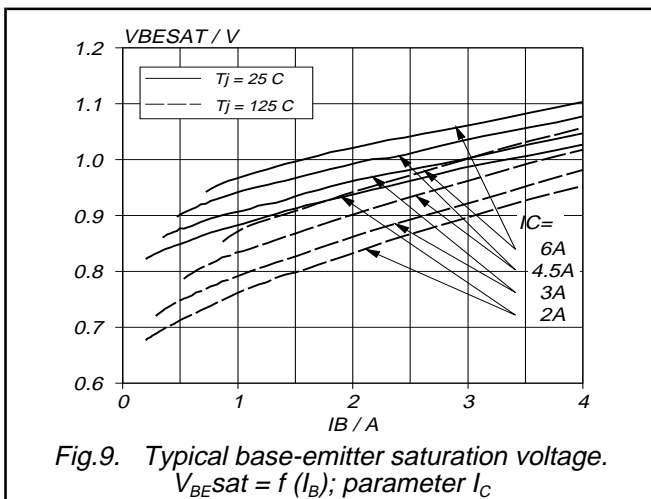
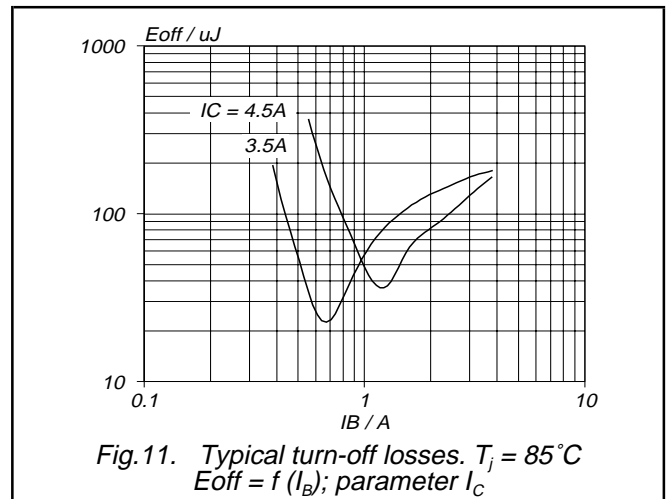
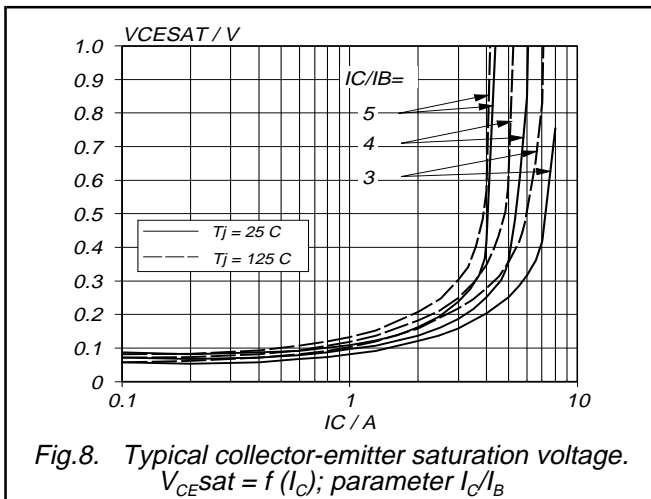
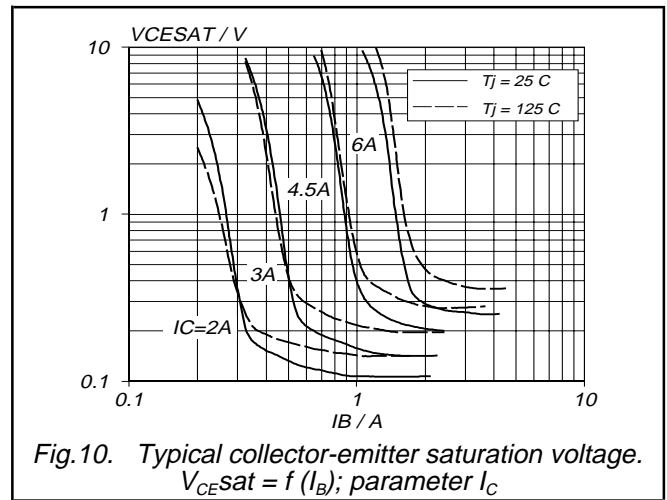
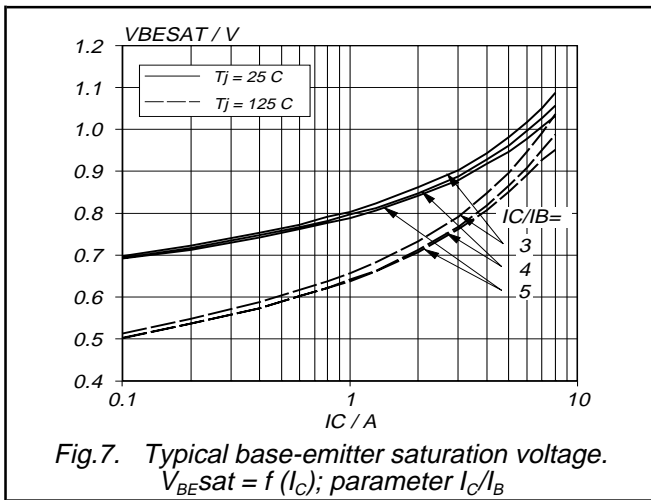

Silicon Diffused Power Transistor

BU1508AX

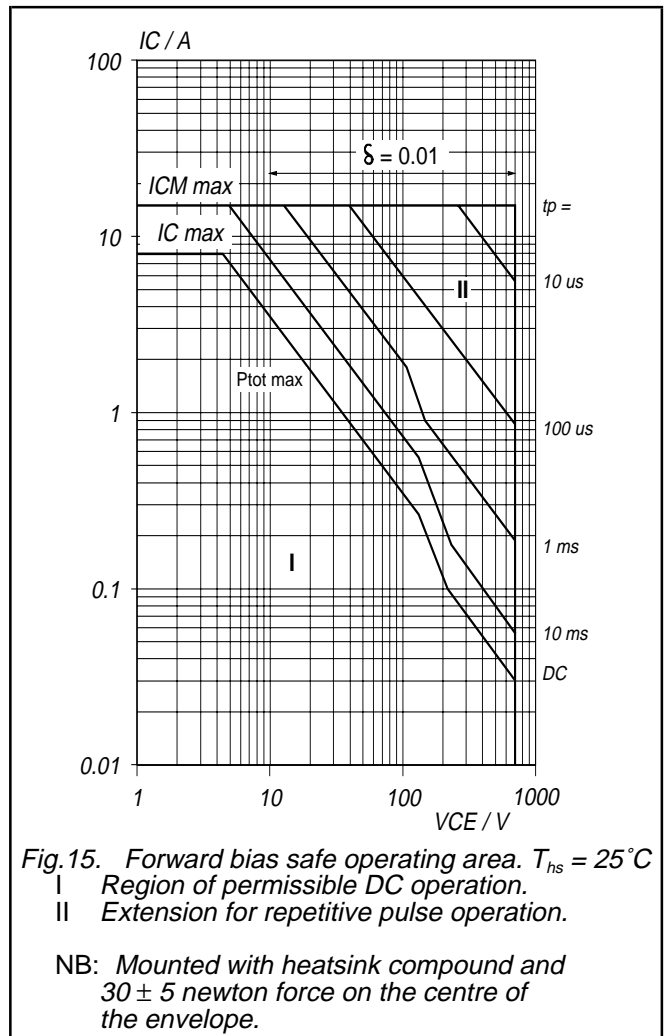
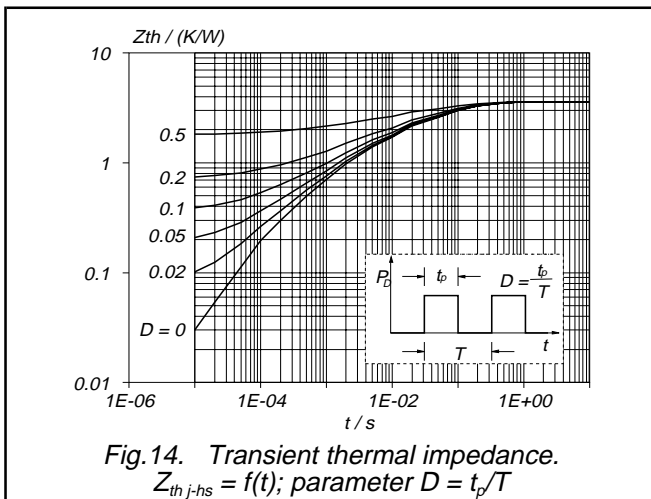

Silicon Diffused Power Transistor

BU1508AX

**MECHANICAL DATA**

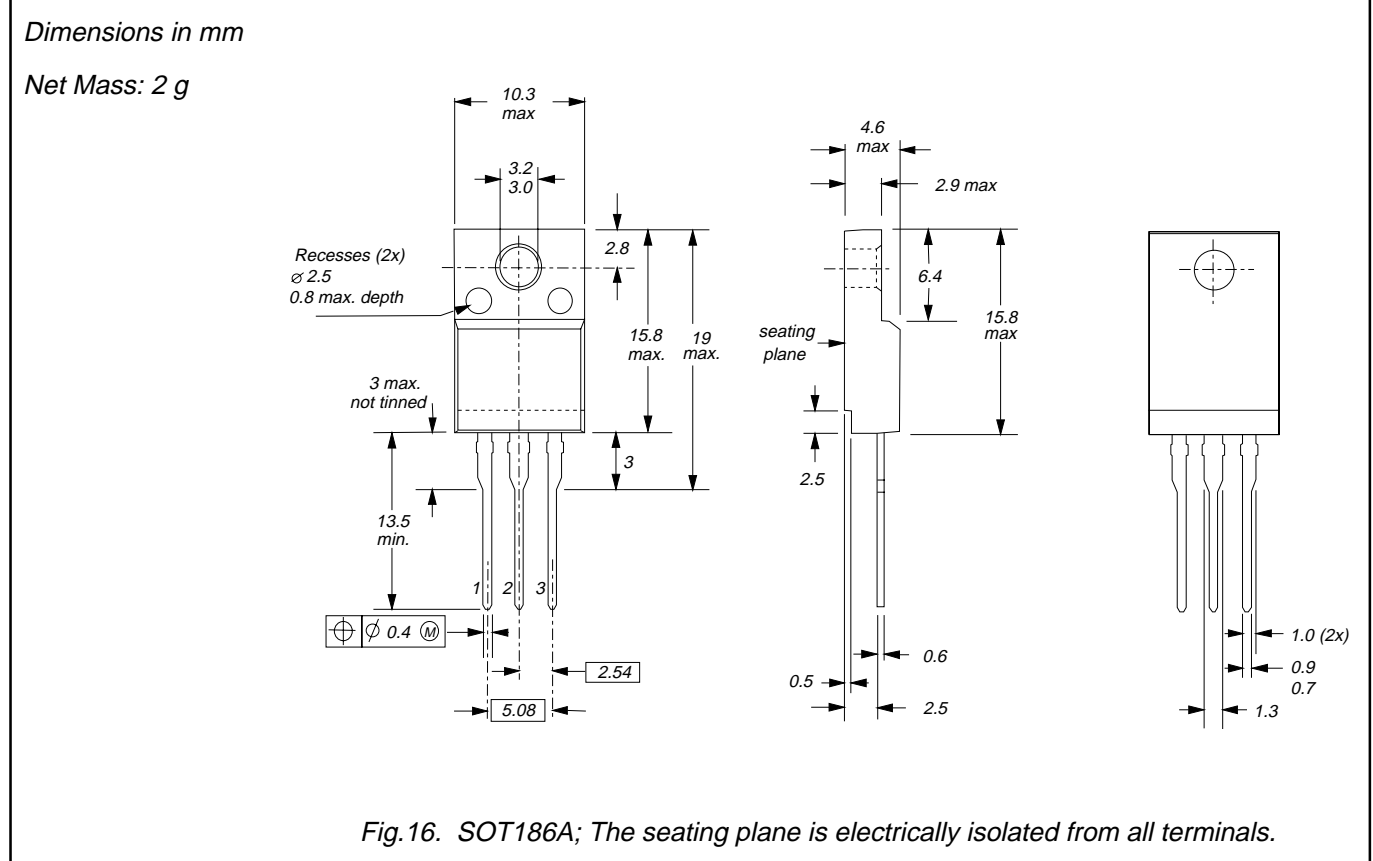

**Notes**

1. Refer to mounting instructions for F-pack envelopes.
2. Epoxy meets UL94 V0 at 1/8".

## Silicon Diffused Power Transistor

BU1508AX

**DEFINITIONS**

<b>Data sheet status</b>	
Objective specification	This data sheet contains target or goal specifications for product development.
Preliminary specification	This data sheet contains preliminary data; supplementary data may be published later.
Product specification	This data sheet contains final product specifications.
<b>Limiting values</b>	
Limiting values are given in accordance with the Absolute Maximum Rating System (IEC 134). Stress above one or more of the limiting values may cause permanent damage to the device. These are stress ratings only and operation of the device at these or at any other conditions above those given in the Characteristics sections of this specification is not implied. Exposure to limiting values for extended periods may affect device reliability.	
<b>Application information</b>	
Where application information is given, it is advisory and does not form part of the specification.	
© Philips Electronics N.V. 1997	
All rights are reserved. Reproduction in whole or in part is prohibited without the prior written consent of the copyright owner.	
The information presented in this document does not form part of any quotation or contract, it is believed to be accurate and reliable and may be changed without notice. No liability will be accepted by the publisher for any consequence of its use. Publication thereof does not convey nor imply any license under patent or other industrial or intellectual property rights.	

**LIFE SUPPORT APPLICATIONS**

These products are not designed for use in life support appliances, devices or systems where malfunction of these products can be reasonably expected to result in personal injury. Philips customers using or selling these products for use in such applications do so at their own risk and agree to fully indemnify Philips for any damages resulting from such improper use or sale.